



## Falcon F35 Series Digital Panel Meter

- Full 3-1/2 Digit, Bright Red 0.56" (14.2mm) Display
- Broad Range Display Scaling
- Short 2.94" (74.7mm) Deep, 1/8 DIN Case
- Screw Terminal Connector for Easy Installation
- Four User-Settable Ranges: 200mV, 2V, 20V, 200V
- One Factory-Settable Range: 750V
- Jumper-Selectable Decimal Point
- Optional Isolated 9-32VDC Power Supply
- Optional Excitation Output of 12VDC or 24VDC



The Falcon Series digital indicators are premium quality 1/8 DIN meters for industrial applications. All Falcon units feature jumper selectable decimal point (internal and on the connector for remote decimal point) and display scaling, providing wide application flexibility. In addition, signal input ranges are easy to change with jumpers on the main board. The Falcon has a 0.56" bright red LED display for high visibility.

Compactly designed for applications requiring minimal rear panel depth, the Falcon fits a standard 1/8 DIN panel cutout (92mm x 45mm) and requires less than 3" behind the panel. A screw terminal connector is a standard feature for easy wiring of the power supply and signal input connections.

### Installation and Panel Cutout

**Mounting Requirements**  
The Falcon series 1/8 DIN indicators require a panel cutout of 1.77" (45mm) high by 3.62" (92mm) wide. To install the Falcon into a panel cutout, remove the clips from the side of the meter. Slide the meter through your panel cutout, then slide the mounting clips back on the meter. Press evenly to ensure a proper fit.

**Engineering Label Placement**  
If replacement of the engineering unit label is required, place the tip of a ball-point pen into the small hole at the base of the engineering label in the bezel. Slide the label up until it pops out. Grasp and remove. Slide the new label half the distance in, then use the ball-point pen to slide it down into place.

# Specifications

## DISPLAY

**Type:** 7-segment, red LED  
**Height:** 0.56" (14.2mm)  
**Decimal Point:** 3-position programmable, internally or on the terminal block  
**Overrange indication:** most significant digit = "1"; other digits blank  
**Polarity:** Automatic, with "-" indication, "+" indication implied

## POWER REQUIREMENTS

**AC Voltages:** 120 or 220VAC, ±10%, 50/60Hz  
**DC Voltages:** 9-32VDC, ±1%  
**Power Consumption:** 3VA

## ACCURACY @25° C

±0.1% of reading ±1 count  
 750 ±2 counts

## ENVIRONMENTAL

**Operating Temperature:** 0 to 55°C  
**Storage Temperature:** -10 to 60°C  
**Relative Humidity:** 0 to 85% non-condensing  
**Temperature Coefficient:** (±0.01% of input ± 0.05 count)/°C  
**Warm-up Time:** Less than 15 minutes  
**Response Time:** Less than 1 second

## NOISE REJECTION

**NMRR:** 50dB, 50/60Hz  
**CMRR:** (with 1KΩ unbalanced @ 60Hz): 90dB min.

## ANALOG TO DIGITAL CONVERSION

**Technique:** Dual slope integration  
**Rate:** 3 samples per second, nominal

## MECHANICAL

**Bezel:** 3.79"x 1.89" x .44"  
 (96 x 48 x 11.2mm)  
**Depth:** 2.94" (74.7mm)  
**Panel Cutout:** 3.6" X 1.77"  
 (91.9 x 45mm 1/8 DIN)  
**Case Material:** 94V-1, UL rated Noryl®  
**Weight:** 9.0oz (255.1g)

## INPUTS: DC Voltage

Input Range	Display Resolution	Input Impedance	Maximum Overload
200mV	100µV	≥100MΩ	50V
2V	1mV	10MΩ	100V
20V	10mV	10MΩ	100V
200V	100mV	10MΩ	250V

# Wiring Diagram

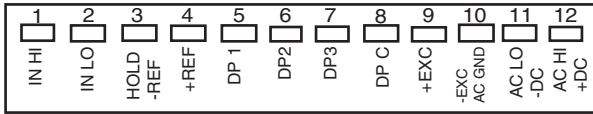

**Input Signal:** Connect the signal to be monitored to the IN HI and IN LO terminals. IN HI is terminal #1, IN LO is terminal #2.

**Supply Power:** Connect the supply power to terminals #11 and #12. Note that if AC power is supplied, terminal #11 is for Neutral, and terminal #12 is for Hot. If DC power is used, terminal #11 is for -DC, and #12 is for +DC.

**Display Hold:** This feature allows you to hold the displayed value indefinitely. A remote switch can be used to make the connection. To activate the display hold, short terminal blocks #3 and #4 (Hold Ref and +Ref). This connection must be kept isolated from other circuitry. To hold multiple units, separate poles of the switch must be used to maintain the isolation.



These instruments are designed for maximum safety to the operator when mounted in a panel according to instructions. They are not to be used unmounted or for exploratory measurements in unknown circuits.



Before switching the instrument on, make sure the supply voltage matches the power source required of the instrument as indicated on the hook-up label affixed to the instrument.

# Decimal Point Selection

**From terminal block:** The decimal point can be set from the rear screw terminal block by connecting the appropriate decimal point (DP 1, 2, 3, ) to the DP C terminal. The J105 jumper must be in the D position (see diagram under "From front panel").

Decimal Point	Connect
1.999	DP C to DP1
19.99	DP C to DP2
199.9	DP C to DP3
1999	No Decimal

**From front panel:** The decimal point can also be selected by removing the front bezel from the meter. Move the push-on jumper J105 across the correct letter.

Decimal Point	Jumper Position at J105__
1.999	A
19.99	B
199.9	C
1999	D*
* No Decimal Point	

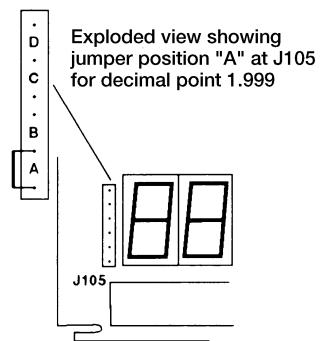

# Voltage Range Selection

All Falcon Indicators are configured initially per the customer specifications. Range changes can be accomplished as follows:

Disconnect power from the unit. Remove the unit from the panel. Remove the front bezel by inserting slotted screwdriver in the vertical slots on either side of the bezel and then turning to pry the bezel off. Unscrew the two Phillips head screws at either side of the circuit board. Finally, push on the green connector assembly in the back of the unit to slide the main circuit board out from the meter. Change jumpers according to the chart below.

Note: If a new range is selected, the calibration procedure must also be performed.

Input Range	J103	J106	JU101	JU102
200mV	C	R	V	Yes
2V	A	R	V	No
20V	B	R	V	No
200V	D	R	V	No

See Chart

Note: JU101 and JU102 are hard wire jumpers, and are removed by cutting them. Resoldering the JU jumpers is not recommended. If this is required, or if a function is to be changed (from volts to current), Simpson recommends returning the Falcon to the factory or an Authorized Service Center. After moving the jumpers to the desired location, put the Falcon back together and install in your panel, or proceed to calibration.

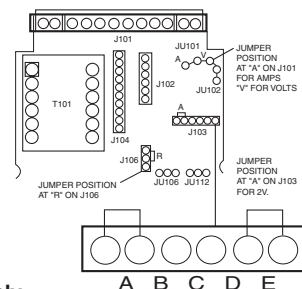

\* 750 volt range may be configured by factory or Simpson Authorized Service Center only.

## Application Example

A manufacturing plant requires a low cost digital meter to replace an analog panel meter on a 150VDC motor. The upgrade is required because the operator requires a display hold feature that is not available on the analog model.

A Falcon 3-1/2 digit indicator (200DCV) can fit this application. The meter needs no additional scaling before being installed into the panel. A switch is required for the display hold option, as one is not supplied by Simpson.

The meter is installed in parallel with the motor like the analog meter, and is ready to be placed in the panel.

The Falcon is less than 3" deep, fitting well into the restricted panel space. It will take up about as much space as the analog meter it replaced. In addition, display hold is a stan-

dard feature on the Falcon. By shorting connections #3 and #4, the operator can hold the display to take a reading, and then remove the short to reactivate the indication mode.

A switch can be used to short the connections. The meter is shipped ready to install, keeping down-time to a minimum.

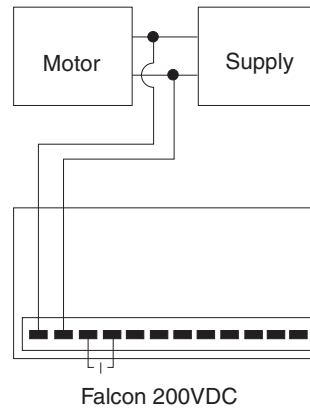

## Ordering Information

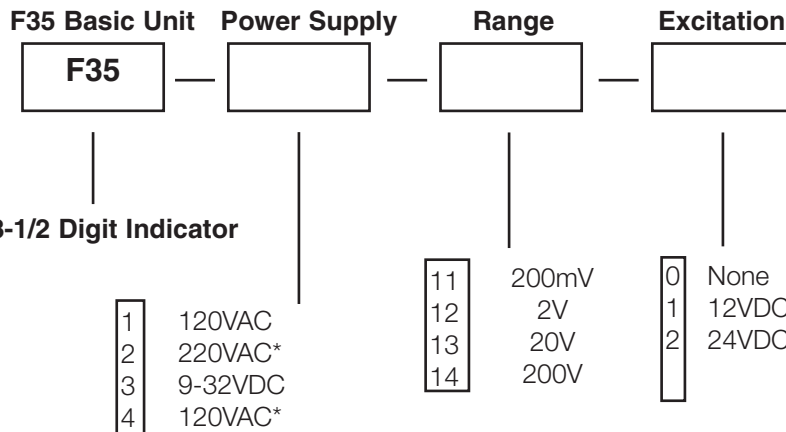

\*Meets CE EMI EN-50082-1, EN-55022, EN-61000-3-2, EN-61000-3-3

## Safety Symbols



The WARNING sign denotes a hazard. It calls attention to a procedure, practice, or the like, which, if not correctly performed or adhered to, could result in personal injury.



The CAUTION sign denotes a hazard. It calls attention to an operating procedure, practice, or the like, which, if not correctly adhered to, could result in damage to or destruction of part or all the instrument.

## Accessories

### Switchboard

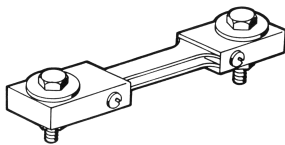

### Portable

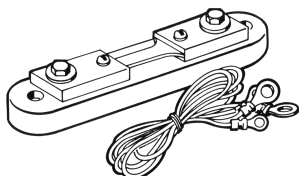

External shunts enable DC volt digital panel meters to indicate higher DC currents than can be provided with self contained internal shunt meters. The shunt is installed in series with the load and the source. The shunts provide a DCmV drop which is sent to the display unit. The Falcon can be scaled to display the current between the load and the source. Simpson offers portable and switchboard shunts.

Each shunt includes 5' leads (0.065Ω resistance). Accuracy is within ±1% of rating.

## Ordering Information

### Portable Shunts ( 50 mV )\*

Amp	Voltage Drop	Jumper Across R114	Range of Readout	Catalog Number
1	50mV	Yes	1.00	06700
5	50mV	Yes	5.00	06706
10	50mV	Yes	10.0	06704
15	50mV	Yes	15.0	06705
20	50 mV	Yes	20.0	N/A
25	50mV	Yes	25.0	06707
30	50mV	None	30.0	06708
50	50mV	None	50.0	06709
75	50mV	None	75.0	06711
100	50mV	Yes	100	06713
150	50mV	Yes	150	06714
200	50mV	Yes	200	06715
10	100mV	Yes	10.0	06716
30	100mV	Yes	30.0	N/A
100	100mV	None	100.0	06717
200	100mV	Yes	200	N/A
10	200mV	Yes	10.00	N/A
20	200mV	Yes	20.0	N/A
100	200mV	Yes	100.0	N/A
200	200mV	None	199.9	N/A

### Switchboard (50 mV)\*\*

Amp	Voltage Drop	Catalog Number
100	50mV	06500
150	50mV	06503
200	50mV	06504
250	50mV	06505
300	50mV	06506
400	50mV	06507
500	50mV	06508

A portable or switchboard shunt should be used with Falcon series 200 mVDC meters. Specifications can be found on data sheet for DC Voltage.

\*\*All switchboard shunts require a jumper across R114.